



TESTED PRODUCTS
EFFICIENT SERVICE
TRUSTED BRAND

An ISO 9001: 2015 Company

Product Catalog



Cable Lugs & Connectors





An ISO 9001:2015 Company

AXIS ELECTRICAL COMPONENTS (I) P. LTD.

Our Vision

To be a leading global enterprise providing innovative & value based solutions in the Electrical & Energy Sector.

Our Mission

AXIS is committed to deliver excellence and superior value to our customers, shareholders, employees and society at large. Our mission is driven through the 4 pillars of:

- 1. Customer Centricity:** To become the "Supplier of Choice", delivering products and services and creating value for our customers.
- 2. People Centricity:** To be the "Employer of Choice", nurturing and developing talent, fostering teamwork & capability with a high sense of pace, passion and pride driven by value & culture.
- 3. Community Centricity:** To be recognized as a responsible corporate citizen through facilities, being legally compliant and driven by a strong corporate governance.
- 4. Business & Technology Centricity:** To drive innovative, efficient & effective systems, processes and delivery backbone backed by technology for a sustainable and scalable business growth and value.



An ISO 9001: 2015 Company

TESTED PRODUCTS
EFFICIENT SERVICE
TRUSTED BRAND

Company Profile

Leading Manufacturer & Exporter

Axis is the leading Indian Manufacturer & Exporter of a wide range of Electrical Components used in Electrical Installations and in the Equipment Building industry. Our main customer base consist of Distributors/Wholesalers of Electrical Products, Electrical Contractors & Installers, Equipment Manufacturers, Maintenance Companies and Government Authorities.

Exports to more than 80 Countries Worldwide

Over the years, Axis has supplied high quality and tested products to thousands of customers in over 80 countries. As a result, the Axis brand has become synonymous with Quality.

International Certifications

Axis invests heavily in continuous improvements in its products and manufacturing processes. This allows Axis to always be ahead of the curve through certifications and approvals from around the world. Products manufactured by Axis follow widely accepted international such as BS, DIN, UL, NFC, AS/NZ & Indian Standard (IS). CRISIL India, an S&P subsidiary, rated Axis as having the highest performance capabilities and strong financial strength.

Constant Improvement

Axis's dual focus on foreseeing customer requirements and looking at the future of the industry, translates to a continuous desire to evolve and upgrade our product offerings.

Quality Management

Our goal is to provide each customer with products, systems and services that meet the highest standards of quality. To assure quality management, Axis has achieved an ISO 9001 Certification.

LUGS

- Installation Procedure
- Introduction
- Compression Cable Lugs - Standard Barrel
- Compression Cable Lugs - Heavy Duty, Long Barrel
- Compression Cable Lugs - Heavy Duty, Long Barrel - Bell Mouthed
- Compression Cable Lugs - N-series
- Compression Cable Lugs - N-series - Bell Mouthed
- Compression Cable Lugs - Din 46235
- Compression Cable Lugs - KRF Series
- Compression Cable Lugs - With Two holes
- Compression Cable Lugs - for Transformer
- Compression Cable Lugs - Brazed Palm for Transformer
- Compression Cable Lugs - Long Palm
- Compression Cable Lugs - Sealed Palm
- Compression Cable Lugs - Narrow Palm

COPPER JOINTS

- Compression Joints - Regular Barrel
- Compression Joints - Long Barrel
- Compression Joints - Heavy Duty - DIN Standard
- Compression Joints - Heavy Duty
- Compression Joints - AKS Series
- Butt Joints
- Compression Through Joints (Non Tension)
- Compression Connectors With Solid Barrier
- Weak Back Ferrules
- Screw Connectors

ALUMINIUM LUGS

- Compression Cable Lugs - Aluminium

ALUMINIUM CONNECTORS

- Compression Joints Aluminium - Long Barrel

BIMETALLIC LUGS

- Compression Cable Lugs - Bimetallic ADTL2 Series
- Compression Cable Lugs - Bimetallic ADTL3 Type

BIMETALLIC JOINTS

- Bimetallic Joints - Straight Type
- Bimetallic Joints - Reducing Type

O-H LINE CONNECTORS

- Compression Midspan Joints (Full Tension) - Aluminium
- Compression Midspan Joints - Aluminium
- Split Bolt Connectors
- Split Bolt Connectors R-Series
- Servit Post Split Bolt Connectors
- Aluminium Line Tap ('V' Type)
- Parallel Groove Connectors - Bimetallic
- Parallel Groove Connectors AL/AL
- Plastic Covers For Pg Clamps

01

- 01
- 02
- 04
- 07
- 10
- 12
- 14
- 16
- 18
- 20
- 22
- 23
- 23
- 24
- 25

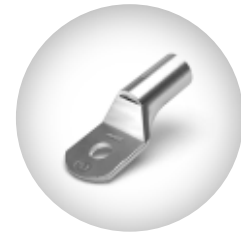

26

- 26
- 26
- 27
- 27
- 28
- 28
- 29
- 29
- 30
- 30



31

- 31

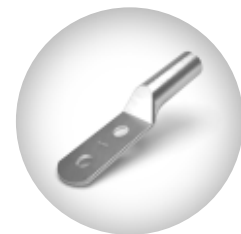

32

- 32



33

- 33
- 34

35

- 35
- 35

36

- 36
- 36
- 37
- 37
- 37
- 37
- 38
- 38
- 39
- 39



Installation Procedure For Lugs & Connectors

1.5 mm² - 1000 mm²

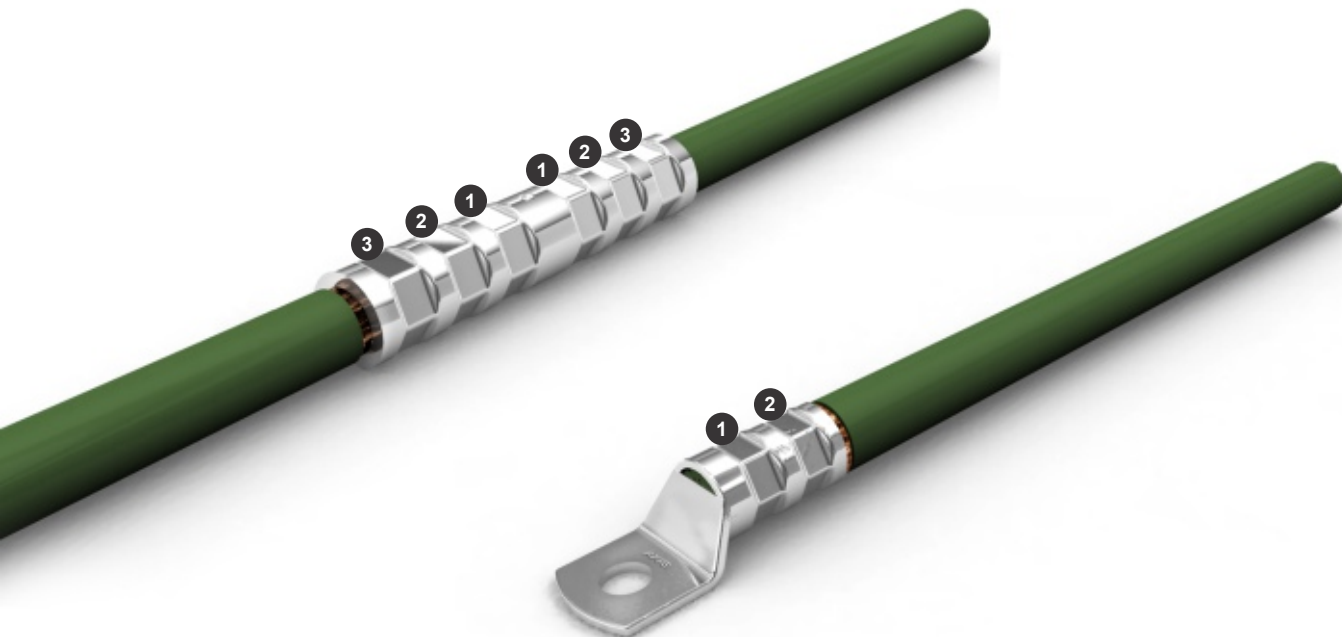

STEPS:

1. Identify the correct Terminal / Connector for the cable in use. This can be done by checking the marking on the connector or from the labels attached to the packages.
2. Necessary cable preparation to be done using suitable stripper to remove the insulation to the distance equal to the insertion depth of the connector plus suitable extra allowances. (3mm to 5mm).
3. Brush the surface of the stranded conductor to remove any oxides if present.
4. Insert the conductor in to the barrel of the connector. Orientation of the palm of the connector should be ensured for the equipment where it is to be connected.
5. Suitable crimping dies / tools should be selected to ensure that the joints made are mechanically strong. Good joint results into good electrical continuity.
6. Ensure proper crimping series (as mentioned above).
7. Clean the surface where the terminal is to be fixed. Necessary nut, bolts, washer as indicated should be used.



Cable Lugs & Connectors



The AXIS Power Lug & Connector product range offers users terminals that are designed and manufactured for fast assembly and reliable performance. AXIS Power Lug terminals are constructed from high-quality materials made with electrolytic copper, aluminium for high conductivity and tin-plated for corrosion resistance. With cable sizes ranging from 0.5 sq.mm to 1200 sq.mm, AXIS Power Lugs are dependable with rapid termination methods for interconnecting heavy gauge power cables to bus bars, relays, batteries, solar power inverters, power cables, grounding devices and more, with increased efficiency, safety, and reduce costs.

The AXIS Power Lug range are designed, manufactured, tested and comply with International Standards like BS, DIN, UL and IEC.

Compression Cable Lugs - Standard Barrel

Material : E-Copper

Finish : Electro-tinned

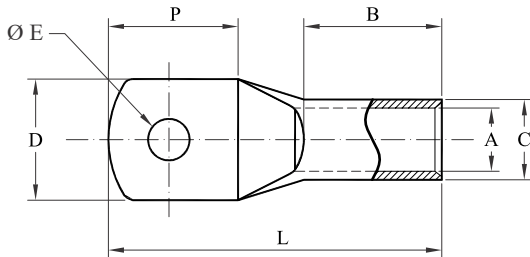

Cable Size mm ²	Stud Size Ø E	Dimensions in mm						E-Code											
		A	C	D	P	B	L												
1.5	4.2	1.8	3.7	8	9	5	16	ATR0001M04											
	5.2				10			ATR0001M05											
	6.2				12			ATR0001M06											
2.5	4.2	2.4	4	8	9	7	18	ATR0002M04											
	5.2				10			12	ATR0002M05										
	6.2							15	ATR0002M06										
	8.2							24	ATR0002M08										
4	5.2	3.1	4.8	10	11	7	21	ATR0004M05											
	6.2			12				15	ATR0004M06										
	8.2							25	ATR0004M08										
6	4.2	3.8	5.5	10	11	11	26	ATR0006M04											
	5.2			12				15	19	30	ATR0006M05								
	6.2									39	ATR0006M06								
	8.2									39	30	ATR0006M08							
	10.5										39	ATR0006M10							
10	5.2	4.5	6.1	11	13	11	28	ATR0010M05											
	6.2			12				17	23	30	ATR0010M06								
	8.2									35	ATR0010M08								
	10.5									35	30	ATR0010M10							
	13										35	ATR0010M12							
16	5.2	5.4	7.1	12	15	13	32	ATR0016M05											
	6.2			17				24	11	36	ATR0016M06								
	8.2										18	24	11	36	ATR0016M08				
	10.5														18	24	11	36	ATR0016M10
	13																		18
	25														5.2	6.8	8.8	13	15
6.2		17	24	13	38	ATR0025M06													
8.2						17	24	13	38	ATR0025M08									
10.5										17	24	13	38	ATR0025M10					
13														17	24			13	

Compression Cable Lugs - Standard Barrel

Material : E-Copper

Finish : Electro-tinned

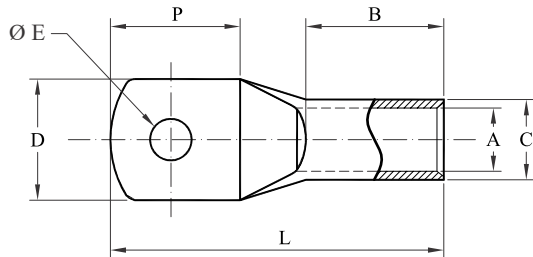

Cable Size mm ²	Stud Size Ø E	Dimensions in mm						E-Code
		A	C	D	P	B	L	
35	5.2	8.2	10.5	15	20	14	38	ATR0035M05
	6.2							ATR0035M06
	8.2							ATR0035M08
	10.5			18	23		41	ATR0035M10
	13							ATR0035M12
	17							ATR0035M16
50	6.2	9.6	12.4	18	20	17	42	ATR0050M06
	8.2							ATR0050M08
	10.5							ATR0050M10
	13							ATR0050M12
	17							ATR0050M16
70	8.2	11.1	14.3	21	24	24	54	ATR0070M08
	10.5							ATR0070M10
	13							ATR0070M12
	14.5			24	27		65	ATR0070M14
	17							ATR0070M16
	10.5							13.6
13	ATR0095M12							
14.5	28	30	60	ATR0095M14				
17				ATR0095M16				
120	8.2	15.1	19.4	28	27	24	60	ATR0120M08
	10.5							ATR0120M10
	13							ATR0120M12
	14.5			33	67		ATR0120M14	
	17						ATR0120M16	
	8.2						16.6	21.1
10.5	ATR0150M10							
13	ATR0150M12							
14.5	ATR0150M14							
17	ATR0150M16							

Compression Cable Lugs - Standard Barrel

Material : E-Copper

Finish : Electro-tinned

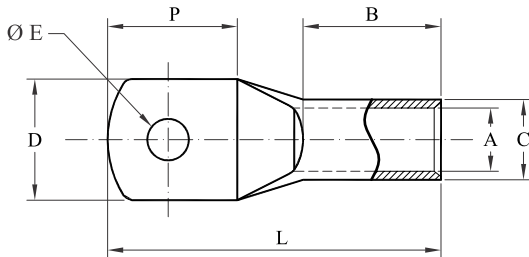

Cable Size mm ²	Stud Size Ø E	Dimensions in mm						E-Code
		A	C	D	P	B	L	
240	10.5	21.1	26.4	38	41	38	92	ATR0240M10
	13							ATR0240M12
	14.5							ATR0240M14
	17							ATR0240M16
	21							ATR0240M20
300	10.5	23.6	29.9	43	45	41	101	ATR0300M10
	13							ATR0300M12
	14.5							ATR0300M14
	17							ATR0300M16
	21							ATR0300M20
	BLANK							ATR0300MBL
400	13	26.5	33.5	48	50	45	113	ATR0400M12
	14.5							ATR0400M14
	17							ATR0400M16
	21							ATR0400M20
	BLANK							ATR0400MBL
500	13	30.1	38.9	56	58	52	130	ATR0500M12
	14.5							ATR0500M14
	17							ATR0500M16
	21							ATR0500M20
	BLANK							ATR0500MBL
630	14.5	34.5	44	65	68	56	148	ATR0630M14
	17							ATR0630M16
	21							ATR0630M20
	27							ATR0630M25
	BLANK							ATR0630MBL
800	17	39	50.6	72	77	78	176	ATR0800M16
	21							ATR0800M20
	BLANK							ATR0800MBL
1000	17	43	56.2	80	90	90	200	ATR1000M16
	21							ATR1000M20
	27							ATR1000M25
	BLANK							ATR1000MBL
1200	27	46	60.4	87	90	100	210	ATR1200M25
	BLANK							ATR1200MBL

Compression Cable Lugs - Heavy Duty, Long Barrel

- Material : E-Copper
- Finish : Electro-Tinned
- Features : With Inspection hole

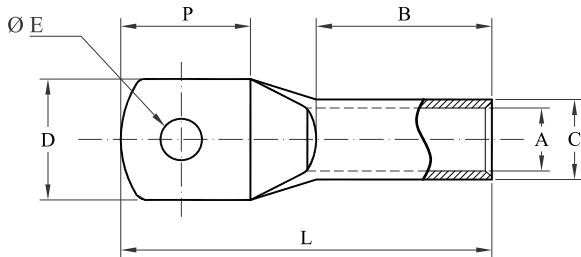

Cable Size mm ²	Stud Size Ø E	Dimensions in mm						E-Code
		A	C	D	P	B	L	
1.5	4.2	1.8	3.7	8	9	5	16	ATH0001M04
	5.2				10			ATH0001M05
	6.2				12			ATH0001M06
2.5	4.2	2.4	4	8	9	7	18	ATH0002M04
	5.2				12		ATH0002M05	
	6.2			15	20		ATH0002M06	
	8.2			15	24		ATH0002M08	
4	5.2	3.1	4.8	10	11	7	21	ATH0004M05
	6.2				15		25	ATH0004M06
	8.2			15	25		ATH0004M08	
6	4.2	3.8	5.5	10	11	11	26	ATH0006M04
	5.2				11		26	ATH0006M05
	6.2			15	30		ATH0006M06	
	8.2			15	30		ATH0006M08	
	10.5			19	39		ATH0006M10	
10	5.2	4.5	6.9	12	14	11	28	ATH0010M05
	6.2				16		30	ATH0010M06
	8.2			21	35		ATH0010M08	
	10.5			24	38		ATH0010M10	
	13			24	38		ATH0010M12	
16	5.2	5.9	8	12	15	20	13	ATH0016M05
	6.2				15		13	ATH0016M06
	8.2			15	13		ATH0016M08	
	10.5			26	50		ATH0016M10	
	13			26	50		ATH0016M12	
25	6.2	7	9.7	14	16	23	42	ATH0025M06
	8.2				23		42	ATH0025M08
	10.5			23	50		ATH0025M10	
	13			23	50		ATH0025M12	
35	6.2	8.4	11.5	16	19	23	46	ATH0035M06
	8.4				19		46	ATH0035M08
	10.5			27	53		ATH0035M10	
	13			27	53		ATH0035M12	
	17			35	63		ATH0035M16	

Compression Cable Lugs - Heavy Duty, Long Barrel

- Material** : E-Copper
- Finish** : Electro-Tinned
- Features** : With Inspection hole

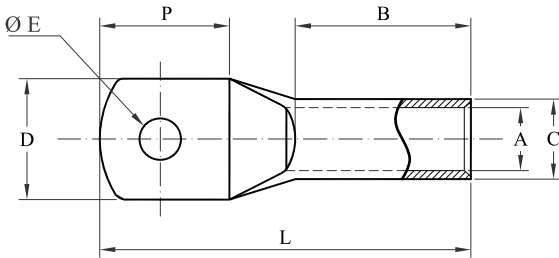

Cable Size mm ²	Stud Size Ø E	Dimensions in mm						E-Code
		A	C	D	P	B	L	
50	6.2	9.5	12.7	18	20	24	49	ATH0050M06
	8.2							ATH0050M08
	10.5			ATH0050M10				
	13			ATH0050M12				
	17			22	26		55	ATH0050M16
70	6.2	11.1	14.3	20	23	24	54	ATH0070M06
	8.2							ATH0070M08
	10.5			ATH0070M10				
	13			ATH0070M12				
	14			ATH0070M14				
	17			25	33		64	ATH0070M16
21	27	44	77	ATH0070M20				
95	6.2	13.6	17.4	25	29	25	60	ATH0095M06
	8.2							ATH0095M08
	10.5				ATH0095M10			
	13				ATH0095M12			
	14				ATH0095M14			
17	33	68	ATH0095M16					
120	8.2	15.5	20.6	29	27	32	70	ATH0120M08
	10.5							ATH0120M10
	13				ATH0120M12			
	14				ATH0120M14			
	17				32		75	ATH0120M16
21	40	84	ATH0120M20					
150	10.5	16.3	22.2	31	34	32	76	ATH0150M10
	13							ATH0150M12
	14							ATH0150M14
	17							ATH0150M16
185	21	18.3	24.3	34	35	32	81	ATH0150M20
	13							ATH0185M12
	14							ATH0185M14
	17							ATH0185M16
	21							ATH0185M20

Compression Cable Lugs - Heavy Duty, Long Barrel

- Material : E-Copper
 Finish : Electro-Tinned
 Features : With Inspection hole

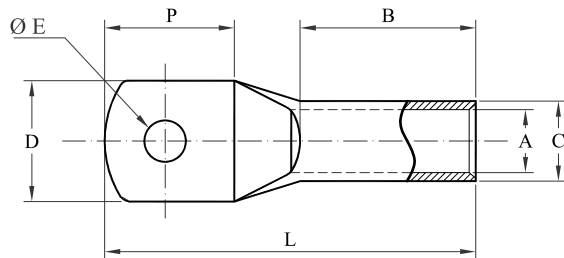

Cable Size mm ²	Stud Size Ø E	Dimensions in mm						E-Code
		A	C	D	P	B	L	
240	10.5	21.2	28.6	40	41	40	99	ATH0240M10
	13							ATH0240M12
	14							ATH0240M14
	17							ATH0240M16
	21							ATH0240M20
	BLANK							ATH0240MBL
300	13	23.8	31.9	45	45	47	107	ATH0300M12
	14							ATH0300M14
	17							ATH0300M16
	21							ATH0300M20
	BLANK							ATH0300MBL
400	13	27.5	35.5	49	51	48	113	ATH0400M12
	14							ATH0400M14
	17							ATH0400M16
	21							ATH0400M20
	BLANK							ATH0400MBL
500	13	30	38	55	60	50	130	ATH0500M12
	14							ATH0500M14
	17							ATH0500M16
	21							ATH0500M20
	BLANK							ATH0500MBL
630	13	34.5	44	64	68	57	146	ATH0630M12
	14							ATH0630M14
	17							ATH0630M16
	21							ATH0630M20
	BLANK							ATH0630MBL
800	17	39	50.6	80	90	90	200	ATH0800M16
	21							ATH0800M20
1000	17	43	56.2	80	90	90	200	ATH1000M16
	21							ATH1000M20
	27							ATH1000M25
	BLANK							ATH1000MBL

Compression Cable Lugs - Heavy Duty, Long Barrel - Bell Mouthed

Material : E-Copper

Finish : Electro-tinned

Features : Bell Mouthed Entry, With Inspection hole

Voltage rating : Up to 11 kV

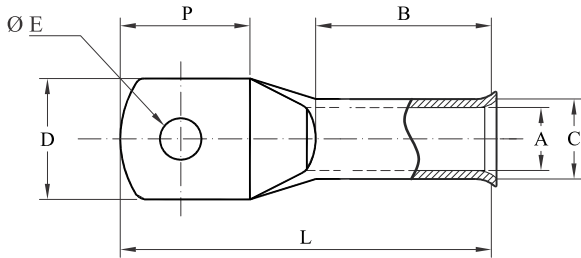

Cable Size mm ²	Stud Size Ø E	Dimensions in mm						E-Code
		A	C	D	P	B	L	
10	5.2	4.5	6.9	12	14	11	28	ATHB0010M05
	6.2				16		30	ATHB0010M06
	8.2			17	21		35	ATHB0010M08
	10.5				24		38	ATHB0010M10
	13							ATHB0010M12
16	5.2	5.9	8	12	15	20	39	ATHB0016M05
	6.2				18		26	50
	8.2			ATHB0016M08				
	10.5			ATHB0016M10				
	13			ATHB0016M12				
25	6.2	7	9.7	14	16	23	42	ATHB0025M06
	8.2			18	23		50	ATHB0025M08
	10.5				ATHB0025M10			
	13			ATHB0025M12				
35	6.2	8.4	11.5	16	19	23	46	ATHB0035M06
	8.4				19		27	53
	10.5			35			63	ATHB0035M10
	13			ATHB0035M12				
	17			ATHB0035M16				
50	6.2	9.5	12.7	18	20	24	49	ATHB0050M06
	8.2				22		26	55
	10.5			ATHB0050M10				
	13			ATHB0050M12				
	17			ATHB0050M16				
70	6.2	11.1	14.3	20	23	24	54	ATHB0070M06
	8.2				25		33	64
	10.5			ATHB0070M10				
	13			ATHB0070M12				
	14			ATHB0070M14				
	17			ATHB0070M16				
21	27	44	77	ATHB0070M20				
95	6.2	13.6	17.4	25	29	25	60	ATHB0095M06
	8.2							ATHB0095M08
	10.5							ATHB0095M10
	13							ATHB0095M12
	14							ATHB0095M14
	17			33	68		ATHB0095M16	

Compression Cable Lugs - Heavy Duty, Long Barrel - Bell Mouthed

Material : E-Copper

Finish : Electro-tinned

Features : Bell Mouthed Entry, With Inspection hole

Voltage rating : Up to 11 kV

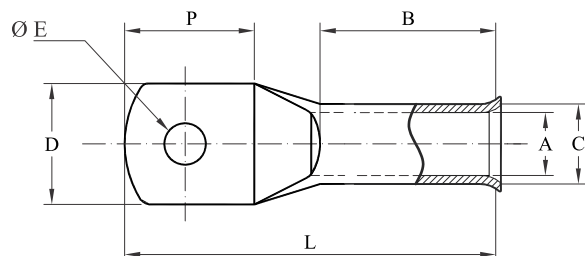

Cable Size mm ²	Stud Size Ø E	Dimensions in mm						E-Code
		A	C	D	P	B	L	
120	8.2	15.5	20.6	29	27	32	70	ATHB0120M08
	10.5							ATHB0120M10
	13				ATHB0120M12			
	14				ATHB0120M14			
	17				32		75	ATHB0120M16
21	40	84	ATHB0120M20					
150	10.5	16.3	22.2	31	34	32	76	ATHB0150M10
	13							ATHB0150M12
	14							ATHB0150M14
	17							ATHB0150M16
	21							ATHB0150M20
185	13	18.3	24.3	34	35	32	81	ATHB0185M12
	14							ATHB0185M14
	17							ATHB0185M16
	21							ATHB0185M20
240	10.5	21.2	28.6	40	41	40	99	ATHB0240M10
	13							ATHB0240M12
	14							ATHB0240M14
	17							ATHB0240M16
	21							ATHB0240M20
BLANK	ATHB0240MBL							
300	13	23.8	31.9	45	45	47	107	ATHB0300M12
	14							ATHB0300M14
	17							ATHB0300M16
	21							ATHB0300M20
BLANK	ATHB0300MBL							
400	13	27.5	35.5	49	51	48	113	ATHB0400M12
	14							ATHB0400M14
	17							ATHB0400M16
	21							ATHB0400M20
BLANK	ATHB0400MBL							
500	13	30	38	55	60	50	130	ATHB0500M12
	14							ATHB0500M14
	17							ATHB0500M16
	21							ATHB0500M20
BLANK	ATHB0500MBL							
630	13	34.5	44	64	68	57	146	ATHB0630M12
	14							ATHB0630M14
	17							ATHB0630M16
	21							ATHB0630M20
BLANK	ATHB0630MBL							
800	17	39	50.6	80	90	90	200	ATHB0800M16
	21							ATHB0800M20

Compression Cable Lugs - N-series

Material : E-Copper

Finish : Electro-Tinned

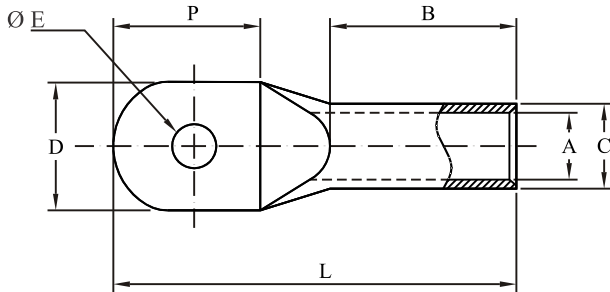

Cable Size mm ²	Stud Size Ø E	Dimensions in mm						E-Code
		A	C	D	P	B	L	
6	5.2	3.8	5.5	10	14	9	28	ATN0006M05
	6.2							ATN0006M06
10	5.2	4.5	6.1	11.5	15.5	9	28.5	ATN0010M05
	6.2							ATN0010M06
	8.2			16	25	12	43	ATN0010M08
	10.5							ATN0010M10
16	6.2	5.5	7.1	12	17	13	36	ATN0016M06
	8.2			16	24	12	43	ATN0016M08
	10.5							ATN0016M10
	13			18	24	12	43	ATN0016M12
25	6.2	6.8	8.8	13	17	13	38	ATN0025M06
	8.2			17	24		43	ATN0025M08
	10.5			17	24	13	43	ATN0025M10
	13							18
35	6.2	8.2	10.5	15	18.5	18	44	ATN0035M06
	8.2			17	21		18	50
	10.5					17		21
	13			17	21		18	
50	6.2	9.6	12.4	18	23	16	49	ATN0050M06
	8.2							ATN0050M08
	10.5							ATN0050M10
	13							ATN0050M12
70	8.2	11.2	14.7	21	25	20	56	ATN0070M08
	10.5							ATN0070M10
	13							ATN0070M12
	14							ATN0070M14
95	10.5	13.6	17.4	25	28	23	62	ATN0095M10
	13							ATN0095M12
	14			33	68	ATN0095M14		
	17					ATN0095M16		
120	10.5	15.1	19.4	28	28	28	72	ATN0120M10
	13							ATN0120M12
	14				33	77	ATN0120M14	
	17						ATN0120M16	
	21						ATN0120M20	

Compression Cable Lugs - N-series

Material : E-Copper

Finish : Electro-Tinned

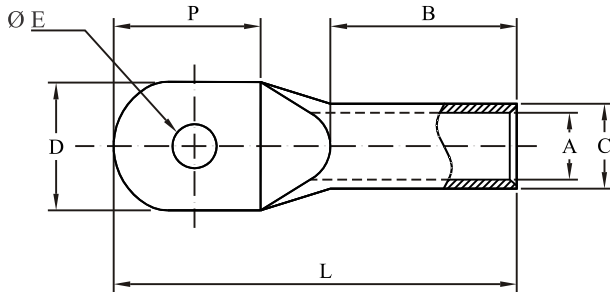

Cable Size mm ²	Stud Size Ø E	Dimensions in mm						E-Code
		A	C	D	P	B	L	
150	10.5	16.6	21.1	30	32	30	75	ATN0150M10
	13							ATN0150M12
	17							ATN0150M16
	21							ATN0150M20
185	10.5	18.6	23.4	34	38	31	85	ATN0185M10
	13							ATN0185M12
	14							ATN0185M14
	17							ATN0185M16
	21							ATN0185M20
240	13	21.1	26.4	38	43	35	95	ATN0240M12
	17							ATN0240M16
	21							ATN0240M20
300	17	23.6	29.9	43	47	44	110	ATN0300M16
	21							ATN0300M20
400	17	27.5	35.5	52	48	45	112	ATN0400M16
	21							ATN0400M20
500	17	30	37	53	50	75	148	ATN0500M16
	21							ATN0500M20
630	17	34	41	60	50	70	148	ATN0630M16
	21							ATN0630M20
800	17	38.5	48.5	70	70	65	168	ATN0800M16
	21							ATN0800M20

Compression Cable Lugs, N-series - Bell Mouthed

Material : E-Copper

Finish : Electro-Tinned

Features : Bell Mouthed Entry, With Inspection hole

Suitability : For Stranded to Fine Stranded Copper

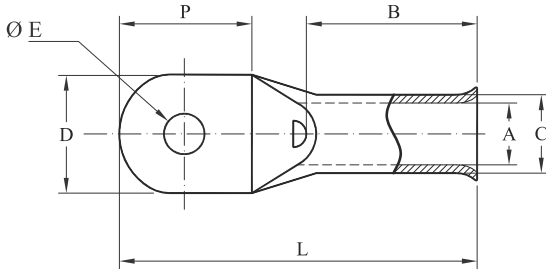

Cable Size mm ²	Stud Size Ø E	Dimensions in mm						E-Code
		A	C	D	P	B	L	
6	5.2	3.8	5.5	10	14	9	28	ATNB0006M05
	6.2							ATNB0006M06
10	5.2	4.5	6.1	11.5	15.5	9	28.5	ATNB0010M05
	6.2							ATNB0010M06
	8.2			16	25	12	43	ATNB0010M08
	10.5							ATNB0010M10
16	6.2	5.5	7.1	12	17	13	36	ATNB0016M06
	8.2			16	24	12	43	ATNB0016M08
	10.5							ATNB0016M10
	13			18	ATNB0016M12			
25	6.2	6.8	8.8	13	17	13	38	ATNB0025M06
	8.2			17	24		43	ATNB0025M08
	10.5					18		ATNB0025M10
	13			ATNB0025M12				
35	6.2	8.2	10.5	15	18.5	18	44	ATNB0035M06
	8.2			17	21		50	ATNB0035M08
	10.5					ATNB0035M10		
	13			ATNB0035M12				
50	6.2	9.6	12.4	18	23	16	49	ATNB0050M06
	8.2							ATNB0050M08
	10.5							ATNB0050M10
	13							ATNB0050M12
70	8.2	11.2	14.7	21	25	20	56	ATNB0070M08
	10.5							ATNB0070M10
	13							ATNB0070M12
	14							ATNB0070M14
95	10.5	13.6	17.4	25	28	23	62	ATNB0095M10
	13							ATNB0095M12
	14				33	68	ATNB0095M14	
	17						ATNB0095M16	
120	10.5	15.1	19.4	28	28	28	72	ATNB0120M10
	13							ATNB0120M12
	14				33	77	ATNB0120M14	
	17						ATNB0120M16	
21	ATNB0120M20							

Compression Cable Lugs, N-series - Bell Mouthed

Material : E-Copper

Finish : Electro-Tinned

Features : Bell Mouthed Entry, With Inspection hole

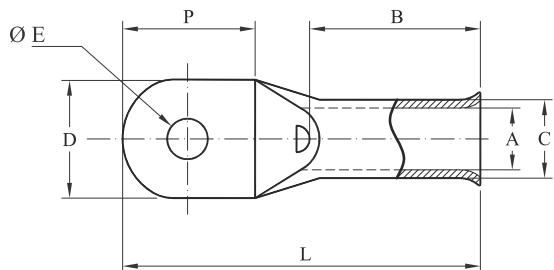

Cable Size mm ²	Stud Size Ø E	Dimensions in mm						E-Code
		A	C	D	P	B	L	
150	10.5	16.6	21.1	30	32	30	75	ATNB0150M10
	13							ATNB0150M12
	17							ATNB0150M16
	21							ATNB0150M20
185	10.5	18.6	23.4	34	38	31	85	ATNB0185M10
	13							ATNB0185M12
	14							ATNB0185M14
	17							ATNB0185M16
	21							ATNB0185M20
240	13	21.1	26.4	38	43	35	95	ATNB0240M12
	17							ATNB0240M16
	21							ATNB0240M20
300	17	23.6	29.9	43	47	44	110	ATNB0300M16
	21							ATNB0300M20
400	17	27.5	35.5	52	48	45	112	ATNB0400M16
	21							ATNB0400M20
500	17	30	37	53	50	75	148	ATNB0500M16
	21							ATNB0500M20
630	17	34	41	60	50	70	148	ATNB0630M16
	21							ATNB0630M20
800	17	38.5	48.5	70	70	65	168	ATNB0800M16
	21							ATNB0800M20

Compression Cable Lugs - DIN Standard

Standard : DIN 46235

Material : E-Copper

Finish : Electro-Tinned

Features : Without Inspection hole

Voltage rating : Up to 36 kV

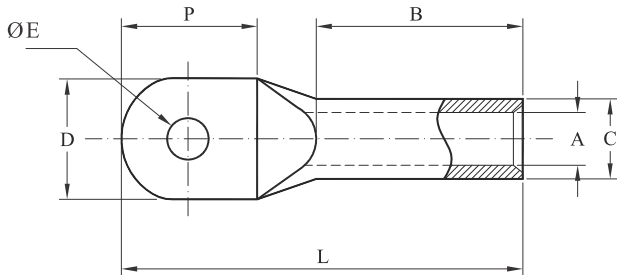

Cable Size mm ²	Stud Size Ø E	Dimensions in mm						E-Code
		A	C	D	P	B	L	
10	5.3	4.5	7	9	15	10	36	ATD0010M05
	6.4			9	16		35	ATD0010M06
	8.4			13	18		39	ATD0010M08
16	6.4	5.5	8.5	13	18	20	48	ATD0016M06
	8.4			23	49		ATD0016M08	
	10.5			27	52		ATD0016M10	
	13			27	53		ATD0016M12	
25	6.4	7	10	14	19	20	48	ATD0025M06
	8.4			16	24		51	ATD0025M08
	10.5			17	27		53	ATD0025M10
	13			19	29		54	ATD0025M12
35	8.4	8.2	12.5	17	23	20	56	ATD0035M08
	10.5			19	27		58	ATD0035M10
	13			21	29		58	ATD0035M12
50	8.4	10	14.5	20	23	28	66	ATD0050M08
	10.5			21	27		70	ATD0050M10
	13			23	29		70	ATD0050M12
70	8.4	11.5	16.5	24	20	28	68	ATD0070M08
	10.5			27	70		ATD0070M10	
	13			29	72		ATD0070M12	
	16			30	35		74	ATD0070M16
95	10.5	13.5	19	27	27	35	82	ATD0095M10
	13			29	84		ATD0095M12	
120	10.5	15.5	21	31	27	35	86	ATD0120M10
	13			29	87		ATD0120M12	
	17			35	90		ATD0120M16	
	21			38	42		92	ATD0120M20

Compression Cable Lugs - DIN Standard

- Standard** : DIN 46235
- Material** : E-Copper
- Finish** : Electro-Tinned
- Features** : Without Inspection hole
- Voltage rating** : Up to 36 kV

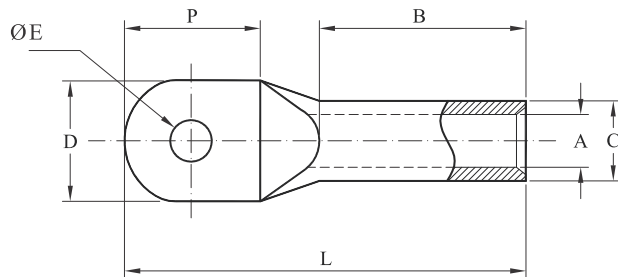

Cable Size mm ²	Stud Size Ø E	Dimensions in mm						E-Code	
		A	C	D	P	B	L		
150	10.5	17	23.5	33	27	35	94	ATD0150M10	
	13			34	29			ATD0150M12	
	17			34	39			97	ATD0150M16
	21			40	42			100	ATD0150M20
185	10.5	19	25.5	36	27	40	97	ATD0185M10	
	13			37	29			100	ATD0185M12
	17			37	35			101	ATD0185M16
	21			40	42			104	ATD0185M20
240	13	21.5	29	41	29	40	108	ATD0240M12	
	17				35			111	ATD0240M16
	21				43			114	ATD0240M20
300	13	24.5	31	45	35	50	118	ATD0300M12	
	17				42			123	ATD0300M16
	21								ATD0300M20
400	17	27.5	38.5	54	41	70	140	ATD0400M16	
	21				45			144	ATD0400M20
500	13	31	42	60	45	70	150	ATD0500M12	
	17							ATD0500M16	
	21							ATD0500M20	
630	17	34	44	62	50	80	160	ATD0630M16	
	21							ATD0630M20	
800	17	40	52	75	60	100	195	ATD0800M16	
	27							ATD0800M20	

Compression Cable Lugs - KRF Series

Material : E-Copper

Finish : Electro - Tinned

Features : With Inspection Hole

Suitability : For Stranded to Fine Stranded Copper Cable

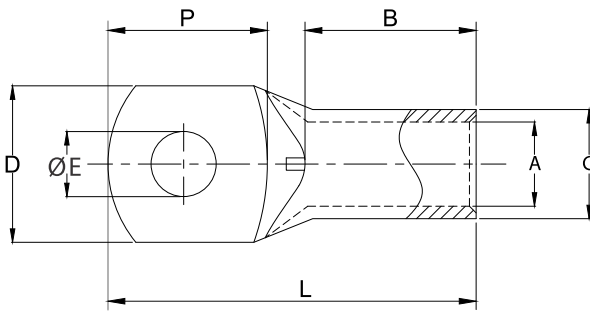

Cable Size mm ²	Stud Size Ø E	Dimensions in mm						E-Code
		A	C	D	P	B	L	
16	5.3	6.0	9.0	13	17	11	34	AKRF0016M05
	6.4							AKRF0016M06
	8.4			AKRF0016M08				
	10.5			16	21		38	AKRF0016M10
	13			22	25		47	AKRF0016M12
25	5.3	8.0	11.0	16	18	14.5	38	AKRF0025M05
	6.4							AKRF0025M06
	8.4			AKRF0025M08				
	10.5			17	27		42	AKRF0025M10
	13			22	27		47	AKRF0025M12
35	6.4	9.0	13.0	18	22	18	45	AKRF0035M06
	8.4							AKRF0035M08
	10.5			AKRF0035M10				
	13			22	28		52	AKRF0035M12
50	6.4	11.0	14.5	21	14	19	50	AKRF0050M06
	8.4							AKRF0050M08
	10.5			AKRF0050M10				
	13			27	33		53	AKRF0050M12
	17			27	33		59	AKRF0050M16
70	6.4	13.0	17.0	25	26	21	55	AKRF0070M06
	8.4							AKRF0070M08
	10.5			AKRF0070M10				
	13			29	35		58	AKRF0070M12
	17			28	35		64	AKRF0070M16
95	8.4	15.0	20.0	29	34	25	69	AKRF0095M08
	10.5							AKRF0095M10
	13							AKRF0095M12
	17							AKRF0095M16
120	10.5	17.0	22.0	32	34	27	73	AKRF0120M10
	13							AKRF0120M12
	17							AKRF0120M16
150	10.5	19.0	25.0	36	36	31	80	AKRF0150M10
	13							AKRF0150M12
	17							AKRF0150M16
	21			39	87		AKRF0150M20	

Compression Cable Lugs - KRF Series

Material : E-Copper

Finish : Electro - Tinned

Features : With Inspection Hole

Suitability : For Stranded to Fine Stranded Copper Cable

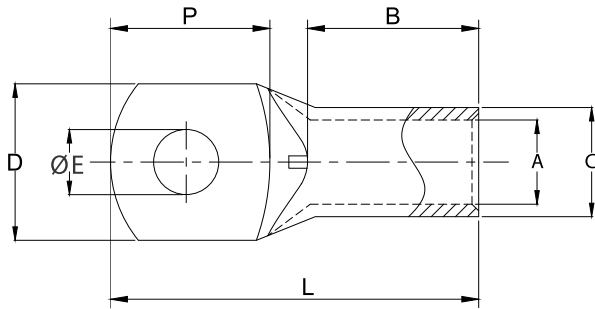

Cable Size mm ²	Stud Size Ø E	Dimensions in mm						E-Code
		A	C	D	P	B	L	
185	10.5	21.0	27.0	39	37	35	86	AKRF0185M10
	13							AKRF0185M12
	17				AKRF0185M16			
	21				39		93	AKRF0185M20
240	10.5	22.5	29.0	42	43	36	95	AKRF0240M10
	13							AKRF0240M12
	17							AKRF0240M16
	21							AKRF0240M20
300	10.5	24.5	31.5	46	57	40	114	AKRF0300M10
	13							AKRF0300M12
	17							AKRF0300M16
	21							AKRF0300M20
	26							AKRF0300M24
400	13	30.0	38.0	56	59	47	126	AKRF0400M12
	17							AKRF0400M16
	21							AKRF0400M20
	24							AKRF0400M24
	BLANK							AKRF0400MBL
500	17	33.0	42.0	61	70	55	150	AKRF0500M16
	21							AKRF0500M20
	26							AKRF0500M24
	BLANK							AKRF0500MBL

Compression Cable Lugs - With 2 Holes

Material : E-Copper

Finish : Electro-Tinned

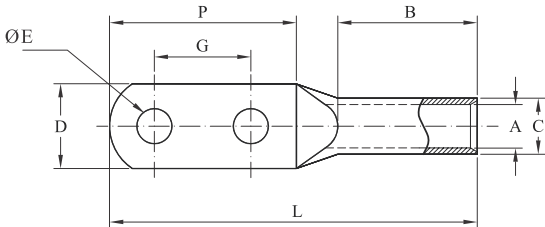

Cable Size mm ²	Stud Size Ø E	Dimensions in mm							E-Code	
		A	C	D	G	P	B	L		
50	10.5	9.6	12.4	18	40	66	28	102	AT2E5010	
	13				44.5	76		112	AT2E5012	
	10.5								AT2E5010N	
	13				AT2E5012N					
70	10.5	11.1	14.3	21	40	66	30	107	AT2E7010	
	13				44.5	76		116	AT2E7012	
	10.5								AT2E7010N	
	13				AT2E7012N					
95	10.5	13.6	17.4	25	40	66	33	111	AT2E9510	
	13				44.5	76		120	AT2E9512	
	10.5								AT2E9510N	
	13				AT2E9512N					
120	10.5	15.1	19.4	28	40	70	36	118	AT2E12010	
	13				44.5	76		124	AT2E12012	
	14.5								AT2E12014	
	10.5				AT2E12010N					
	13				AT2E12012N					
	14.5				AT2E12014N					
150	10.5	16.6	21.1	31	40	72	44	130	AT2E15010	
	13				44.5	76		134	AT2E15012	
	14.5								AT2E15014	
	10.5				AT2E15010N					
	13				AT2E15012N					
	14.5				AT2E15014N					
185	13	18.6	23.4	35	40	76	55	149	AT2E18512	
	14.5				44.5			76	149	AT2E18514
	17									AT2E18516
	13				AT2E18512N					
	14.5				AT2E18514N					
	17				AT2E18516N					

Compression Cable Lugs - With 2 Holes

Material : E-Copper

Finish : Electro-Tinned

Features : With/Without Inspection hole

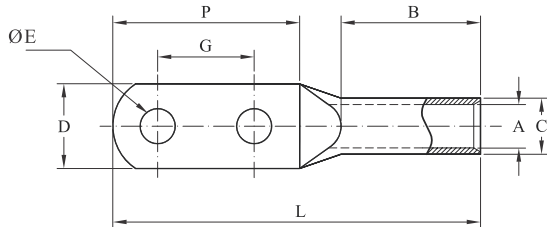

Cable Size mm ²	Stud Size Ø E	Dimensions in mm							E-Code
		A	C	D	G	P	B	L	
240	13	21.1	26.4	38	40	78	55	150	AT2E24012
	14.5				AT2E24014				
	17				AT2E24016				
	13				AT2E24012N				
	14.5				AT2E24014N				
	17				AT2E24016N				
300	13	23.6	29.9	42	40	78	55	160	AT2E30012
	14.5				AT2E30014				
	17				AT2E30016				
	13				AT2E30012N				
	14.5				AT2E30014N				
	17				AT2E30016N				
400	13	27.5	35.5	52	40	80	62	165	AT2E40012
	14.5				AT2E40014				
	17				AT2E40016				
	13				AT2E40012N				
	14.5				AT2E40014N				
	17				AT2E40016N				
500	13	30	37	55	40	80	62	165	AT2E50012
	14.5				AT2E50014				
	17				AT2E50016				
	13				AT2E50012N				
	14.5				AT2E50014N				
	17				AT2E50016N				
630	13	34	41	60	40	82	70	180	AT2E63012
	14.5				AT2E63014				
	17				AT2E63016				
	13				AT2E63012N				
	14.5				AT2E63014N				
	17				AT2E63016N				

Compression Cable Lugs for Transformer

Material : E-Copper

Finish : Electro-Tinned

Features : With/Without Inspection hole

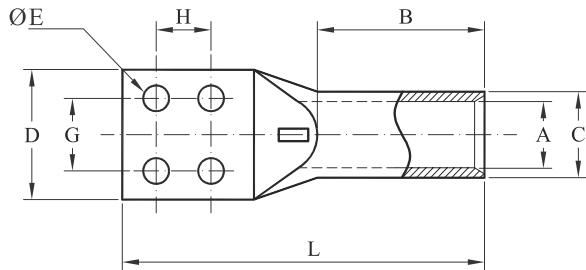

Cable Size mm ²	Stud Size ØE	Dimensions in mm							E-Code
		A	C	D	G	H	B	L	
240	8.5	21	28	58	35	25	45	110	ATT2404E8
	10.5								ATT2404E10
300	8.5	23.5	31	58	35	25	50	115	ATT3004E8
	10.5								ATT3004E10
400	8.5	27.5	35.5	58	35	25	52	120	ATT4004E8
	10.5								ATT4004E10
500	8.5	30.1	38.9	58	35	25	56	124	ATT5004E8
	10.5								ATT5004E10
630N	8.5	34	41	60	35	25	70	145	ATN6304E8
	10.5								ATN6304E10
630	8.5	34.5	44	65	35	25	66	145	ATT6304E8
	10.5								ATT6304E10
800	8.5	39	50.6	73	35	25	90	170	ATT8004E8
	10.5								ATT8004E10
1000	8.5	43	56.2	81	35	25	100	200	ATT10004E8
	10.5								ATT10004E10

Compression Cable Lugs Brazed Palm for Transformer

Material : E-Copper

Finish : Electro-Tinned

Features : With/Without Inspection hole

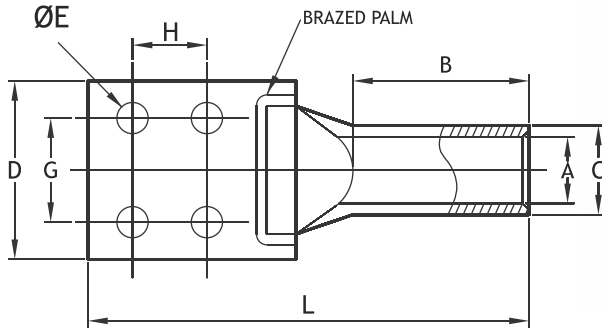

Cable Size mm ²	Stud Size Ø E	Dimensions in mm							E-Code
		A	C	D	G	H	B	L	
185	8.5	18.5	23.6	60	35	25	31	121	ABP1854E8
	10.5								ABP1854E10
240	8.5	21	26.5	60	35	25	35	126	ABP2404E8
	10.5								ABP2404E10
300	8.5	23.5	30	60	35	25	44	137	ABP3004E8
	10.5								ABP3004E10
400	8.5	27.5	35.5	60	35	25	40	139	ABP4004E8
	10.5								ABP4004E10

Compression Cable Lugs - Long Palm

Material : E-Copper

Finish : Electro-Tinned

Features : With/Without Inspection hole

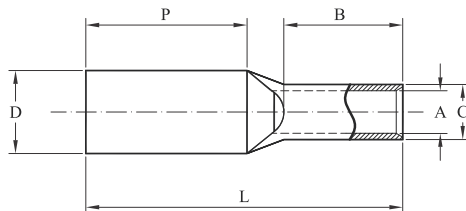

Cable Size mm ²	Stud Size Ø E	Dimensions in mm						E-Code
		A	C	D	P	B	L	
10	BLANK	4.5	6.9	20	67	11	82	ALR0010MBL
16	BLANK	5.9	8.1	20	67	20	91	ALR0016MBL
25	BLANK	7	9.7	18	66	22	95	ALR0025MBL
35	BLANK	8.4	11.5	18	71	22	97	ALR0035MBL
50	BLANK	9.5	12.7	22	71	22	99	ALR0050MBL
70	BLANK	11.1	14.3	28	88	25	120	ALR0070MBL
95	BLANK	13.5	17.5	26	74	25	106	ALR0095MBL
120	BLANK	15.5	20.6	29	74	32	113	ALR0120MBL
150	BLANK	16.3	22.2	33	82	32	122	ALR0150MBL
185	BLANK	18.3	24.3	35	82	32	122	ALR0185MBL
240	BLANK	21.2	28.6	40	86	42	145	ALR0240MBL
300	BLANK	23.8	31.9	45	94	47	160	ALR0300MBL
400	BLANK	27.5	35.5	49	94	50	164	ALR0400MBL
500	BLANK	30	38	55	94	50	164	ALR0500MBL
630	BLANK	34.5	44	63	98	55	173	ALR0630MBL

Compression Cable Lugs - Sealed Palm

Material : E-Copper

Finish : Electro-Tinned

Features : Without Inspection hole

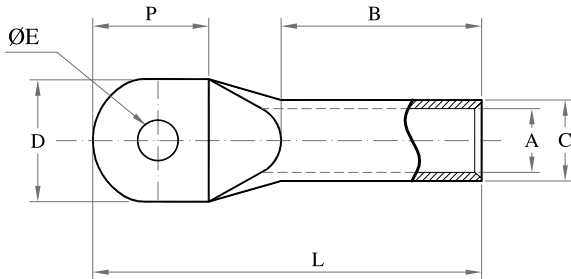

Cable Size mm ²	Stud Size Ø E	Dimensions in mm						E-Code
		A	C	D	P	B	L	
16	13	5.9	8	20	24	34	65	ASP1612SP
	BLANK							ASP16BLSP
25	13	7	9.7	18	21	41	69	ASP2512SP
	BLANK							ASP25BLSP
35	13	8.4	11.5	22	25	41	75	ASP3512SP
	BLANK							ASP35BLSP
50	13	9.5	12.7	22	27	41	78	ASP5012SP
	BLANK							ASP50BLSP
70	13	11.1	14.3	21	25	47	80	ASP7012SP
	BLANK			28				45
95	13	13.5	17.5	26	31	47	89	ASP9512SP
	BLANK							ASP95BLSP
120	13	15.5	20.6	29	33	62	104	ASP12012SP
	BLANK							ASP120BLSP
150	13	16.3	22.2	33	32	62	112	ASP15012SP
	17				38		118	ASP15016SP
	BLANK				ASP150BLSP			
185	13	18.3	24.3	35	32	62	112	ASP18512SP
	17				35		118	ASP18516SP
	BLANK				ASP185BLSP			
240	13	21.2	28.6	40	42	77	144	ASP24012SP
	17							ASP24016SP
	BLANK							ASP240BLSP
300	17	23.8	31.9	45	50	88	163	ASP30016SP
	21							ASP30020SP
	BLANK							ASP300BLSP
400	17	27.5	35.5	49	50	88	163	ASP40016SP
	21							ASP40020SP
	BLANK							ASP400BLSP
500	17	30	38	55	50	88	167	ASP50016SP
	21							ASP50020SP
	BLANK							ASP500BLSP
630	17	34.5	44	63	55	100	192	ASP63016SP
	21							ASP63020SP
	BLANK							ASP630BLSP

Compression Cable Lugs - Narrow Palm

Material : E-Copper

Finish : Electro-Tinned

Features : Without Inspection hole

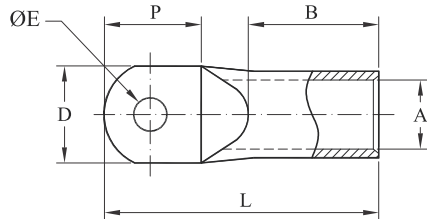

Cable Size mm ²	Stud Size Ø E	Dimensions in mm					E-Code
		A	D	P	B	L	
35	6.5	8.2	15	17	16	44	ANP0035M06
	8.5						ANP0035M08
50	6.5	9.5	19	20	19	49	ANP0050M06
	10.5						ANP0050M10
70	6.5	11.2	19	21	21	51	ANP0070M06
	10.5						ANP0070M10
95	8.5	13.5	19	21	23	55	ANP0095M08
	10.5						ANP0095M10
120	8.5	15.5	20	23	28	63	ANP0120M08
	10.5						ANP0120M10
150	8.5	16.5	20	27	28	68	ANP0150M08
	10.5						ANP0150M10
185	10.5	18.5	25	32	31	74	ANP0185M10
	13						ANP0185M12
240	10.5	21.5	31	32	35	83	ANP0240M10
	13						ANP0240M12
300	10.5	23.5	31	32	44	87	ANP0300M10
	13						ANP0300M12

Compression Joints - Regular Barrel

Material : E-Copper

Finish : Electro-Tinned

Features : Cable Stop Facility

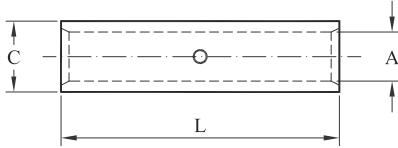

Cable Size mm ²	Dimensions in mm			E-Code
	A	C	L	
1.5	1.8	3.7	12	ARB0001
2.5	2.4	4	15	ARB0002
4	3.1	4.8	15	ARB0004
6	3.8	5.5	15	ARB0006
10	4.5	6.2	20	ARB0010
16	5.4	7.1	20	ARB0016
20	6.1	7.7	22	ARB0020
25	6.8	8.8	32	ARB0025
35	8.2	10.6	36	ARB0035
50	9.5	12.4	40	ARB0050
70	11.1	14.3	45	ARB0070
95	13.5	17.4	45	ARB0095
120	15	19.4	45	ARB0120
150	16.5	21.2	55	ARB0150
185	18.5	23.5	60	ARB0185
240	21	26.5	80	ARB0240
300	23.5	30	85	ARB0300
400	27.5	35.5	85	ARB0400
500	30	38	100	ARB0500
630	34.5	44	110	ARB0630
800	39	50.6	150	ARB0800
1000	43	56.2	170	ARB1000



Compression Joints - Long Barrel

Material : E-Copper Finish : Electro-Tinned Features : Cable Stop Facility

Cable Size mm ²	Dimensions in mm			E-Code
	A	C	L	
1.5	1.8	3.7	22	ALB0001
2.5	2.4	4	22	ALB0002
4	3.1	4.8	22	ALB0004
6	3.8	5.5	22	ALB0006
10	4.5	6.2	22	ALB0010
16	5.4	7.1	35	ALB0016
20	6.1	7.7	35	ALB0020
25	6.8	8.8	35	ALB0025
35	8.2	10.6	47	ALB0035
50	9.5	12.4	47	ALB0050
70	11.1	14.3	50	ALB0070
95	13.5	17.4	50	ALB0095
120	15	19.4	65	ALB0120
150	16.5	21.2	65	ALB0150
185	18.5	23.5	65	ALB0185
240	21	26.5	89	ALB0240
300	23.5	30	89	ALB0300
400	27.5	35.5	90	ALB0400
500	30	38	115	ALB0500
630	34.5	44	115	ALB0630
800	39	50.6	200	ALB0800
1000	43	56.2	230	ALB1000



Compression Joints - Heavy Duty

Standard : DIN 46267, Part 1 Material : E-Copper Finish : Electro-Tinned

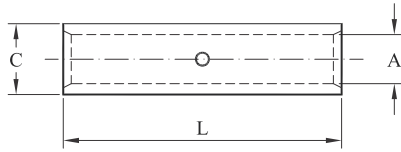

Cable Size mm ²	Dimensions in mm			E-Code
	A	C	L	
6	3.8	5.5	30	ADC0006
10	4.5	6	30	ADC0010
16	5.5	8.5	50	ADC0016
25	7	10	50	ADC0025
35	8.2	12.5	50	ADC0035
50	10	14.5	56	ADC0050
70	11.5	16.5	56	ADC0070
95	13.5	19	70	ADC0095
120	15.5	21	70	ADC0120
150	17	23.5	80	ADC0150
185	19	25.5	85	ADC0185
240	21.5	29	90	ADC0240
300	24.5	31	100	ADC0300
400	27.5	38.5	150	ADC0400
500	31	42	160	ADC0500
630	34	44	160	ADC0630
800	40	52	200	ADC0800
1000	44	58	200	ADC1000



Compression Joints - Heavy Duty

Material : E-Copper Finish : Electro-Tinned
Features : Cable Stop Facility Voltage rating : Up to 11 KV

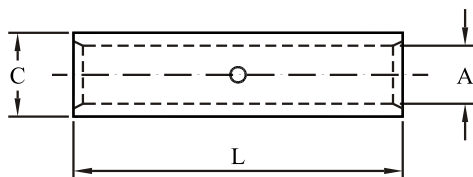

Cable Size mm ²	Dimensions in mm			E-Code
	A	C	L	
10	4.5	6.9	26	ABS0010
16	5.9	8	36	ABS0016
25	7	9.7	47	ABS0025
35	8.4	11.5	47	ABS0035
50	9.5	12.7	47	ABS0050
70	11.1	14.3	54	ABS0070
95	13.6	17.4	54	ABS0095
120	15.5	20.6	68	ABS0120
150	16.3	22.2	68	ABS0150
185	18.3	24.3	68	ABS0185
240	21.2	28.6	88	ABS0240
300	23.8	31.9	98	ABS0300
400	26.8	34.8	98	ABS0400
500	30	38	98	ABS0500
630	33.5	45	103	ABS0630
800	39	50.6	145	ABS0800



Compression Joints - AKS Series

Material : E-Copper

Finish : Electro - Tinned

Features : Cable Stop Facility

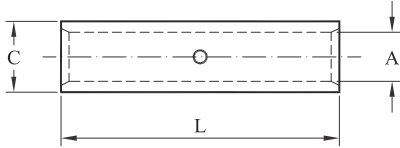

Cable Size mm ²	Dimensions in mm			E-Code
	A	C	L	
0.75	1.3	2.8	14	AKS0075
1.5	1.8	3.3	14	AKS0001
2.5	2.3	4.2	16	AKS0002
4	3	5	19	AKS0004
6	4	6	19	AKS0006
10	5	8	30	AKSF0010
16	6	9	35	AKSF0016
25	8	11	35	AKSF0025
35	9	13	35	AKSF0035
50	11	14.5	45	AKSF0050
70	13	17	45	AKSF0070
95	15	20	45	AKSF0095
120	17	22	55	AKSF0120
150	19	25	65	AKSF0150
185	21	27	70	AKSF0185
240	22.5	29	70	AKSF0240
300	24.5	31.5	75	AKSF0300
400	30	38	100	AKSF0400
500	33	42	135	AKSF0500
630	39	53	175	AKSF0630
800	42.0	53	175	AKSF0800

Butt Joints

Material : E-Copper Finish : Electro-Tinned

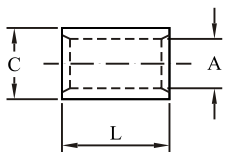

Cable Size mm ²	Dimensions in mm			E-Code
	A	C	L	
1.5	1.8	3.7	6	ABC0001
2.5	2.4	4	6	ABC0002
4	3.1	4.8	9	ABC0004
6	3.8	5.5	9	ABC0006
10	4.5	6.2	10.4	ABC0010
16	5.4	7.1	11.2	ABC0016
25	6.8	8.8	15.5	ABC0025
35	8.2	11	13	ABC0035
50	9.5	13	15.5	ABC0050
70	11.1	14.3	17	ABC0070
95	13.5	17.4	20.5	ABC0095
120	15	19.4	20.5	ABC0120
150	16.5	21.2	23	ABC0150
185	18.5	23.5	29	ABC0185
240	21	26.5	35	ABC0240
300	23.5	30	39	ABC0300

Compression Through Joints (non Tension)

Material : E-Copper

Finish : Untinned

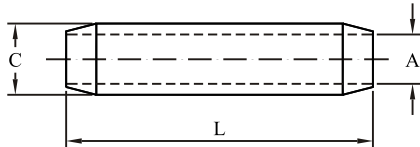

Cable Size mm ²	Dimensions in mm			E-Code
	A	C	L	
25	7	10	60	ANT0025
35	8.2	12.5	60	ANT0035
50	10	14.5	65	ANT0050
70	11.5	16.5	65	ANT0070
95	13.5	19	90	ANT0095
120	15.5	21	90	ANT0120
150	16.5	23.5	105	ANT0150
185	19	25	105	ANT0185
240	21.5	28.5	125	ANT0240
300	23.5	31.5	125	ANT0300
400	27.5	37.5	160	ANT0400
500	30	38	180	ANT0500
630	34.5	44	180	ANT0630

*TINNING ON REQUEST

Compression Connectors With Solid Barrier

Material : E-Copper Finish : Electro-Tinned

Voltage rating : Up to 36 kV

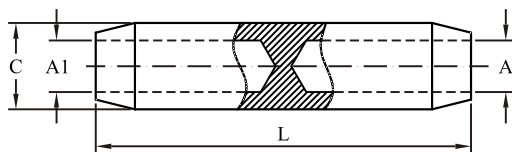

Cable Size		Dimensions in mm				E-Code
mm ²	mm ²	A	A1	C	L	
35	35	8.2	8.2	11	60	ASB0035
35	50	8.2	10	13	60	ASB3550
50	50	10	10	13	60	ASB0050
50	70	10	11.5	16	65	ASB5070
70	70	11.5	11.5	16	65	ASB0070
70	95	11.5	14	20	85	ASB7095
95	95	14	14	20	85	ASB0095
95	120	14	15.5	22	95	ASB9512
120	120	15.5	15.5	22	95	ASB0120
120	150	15.5	17	24	105	ASB1215
150	150	17	17	24	105	ASB0150
150	185	17	19	24	115	ASB1518
120	185	15.5	19	24	115	ASB1218
185	185	19	19	24	115	ASB0185
185	240	19	21.5	28	125	ASB1824
240	240	21.5	21.5	28	125	ASB0240
150	240	17	21.5	28	125	ASB1524
240	300	21.5	24.5	31.5	140	ASB2430
185	300	19	24.5	31.5	140	ASB1830
300	300	24.5	24.5	31.5	140	ASB0300
300	400	24.5	27.5	36.5	170	ASB3040
400	400	27.5	27.5	36.5	170	ASB0400

Weak Back Ferrules

Material : E-Copper

Finish : Electro-Tinned

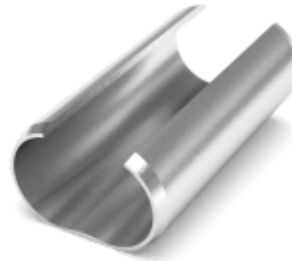
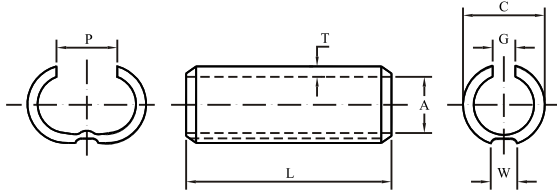

Cable Size mm ²	Dimensions in mm							E-Code
	A	C	G	L	T	P	W	
6	3	4.6	2	20	0.8	3	-	AWB0006
10	4.5	6.2	2	25	0.8	4	-	AWB0010
16	5.5	8.5	2	25	1	5	1.5	AWB0016
25	7	9.7	2	30	1	7	1.5	AWB0025
35	8.2	10.6	2	35	1.2	8	1.5	AWB0035
50	9.5	12.4	2	40	1.2	9	1.5	AWB0050
70	11.1	14.3	3	45	1.4	12	3	AWB0070
95	13.6	17.4	3	50	1.9	13	3	AWB0095
120	15	19.4	4	55	1.6	15	3	AWB0120
150	16.5	21	4	60	1.8	16	3.4	AWB0150
185	18.5	23.5	4	65	2.2	18	5	AWB0185
240	21	26.5	5	80	2.2	21	5	AWB0240
300	23.5	30	5	85	2.8	23	5	AWB0300
400	27.5	35.5	7	95	3.1	27	5	AWB0400
500	30	37	7	105	3.5	30	5	AWB0500
625	34.5	44	8	115	4	33	5	AWB0625

Screw Connectors

Material : Brass

Finish : Electro-Tinned

Screws : Zinc Plated Steel

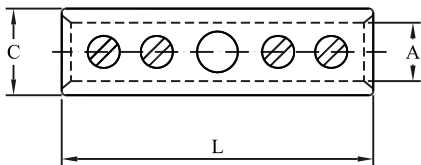

Cable Size mm ²	Dimensions in mm					E-Code
	A	C	L	NOs OF SCREWS	SCREWS SIZE	
10	4.4	9	30	2	M4	ASC10
16	5.5	10	40	4	M4	ASC16
25	6.8	11	45	4	M5	ASC25
35	8.2	13	45	4	M5	ASC35
50	9.5	15	48	4	M6	ASC50
70	11.2	17	52	4	M6	ASC70
95	13.5	20	55	4	M8	ASC95
120	15	22	55	4	M8	ASC120
150	16.5	25	60	4	M10	ASC150
185	19	27	60	4	M10	ASC185
240	21	29	65	4	M10	ASC240
300	23.5	32	65	4	M10	ASC300

Compression Cable Lugs - Aluminium

Material : Electrolytic Grade AL 99.5

Finish : Bright or Electro-tinned

Features : Barrel Prefilled with Oxide inhibiting Compound & Capped at

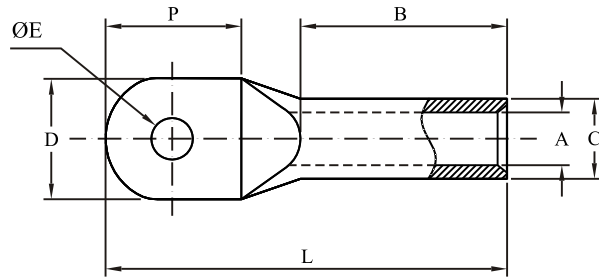

Cable Size mm ²	Stud Size Ø E	Dimensions in mm						E-Code
		A	C	D	P	B	L	
16	8.2	5.5	11	20	21	41	69	AAH0016M08
	10.5							AAH0016M10
25	8.2	6.5	15	22	21	41	69	AAH0025M08
	10.5							AAH0025M10
35	10.5	8	15	25	22	50	79	AAH0035M10
	13							AAH0035M12
50	10.5	9.7	18	26	24	50	81	AAH0050M10
	13							AAH0050M12
70	10.5	11	18	26	26	62	95	AAH0070M10
	13							AAH0070M12
95	10.5	13.1	20	29	28	73	109	AAH0095M10
	13							AAH0095M12
	17							AAH0095M16
120	13	14.7	22	32	30	73	114	AAH0120M12
	17							AAH0120M16
	21							AAH0120M20
150	13	16.5	25	36	34	83	128	AAH0150M12
	17							AAH0150M16
	21							AAH0150M20
185	13	18.1	28	45	36	83	131	AAH0185M12
	17							AAH0185M16
	21							AAH0185M20
240	13	21	28	45	44	86	144	AAH0240M12
	17							AAH0240M16
	21							AAH0240M20
300	17	23.2	34	55	54	89	157	AAH0300M16
	21							AAH0300M20
400	17	26	38	55	60	113	187	AAH0400M16
	21							AAH0400M20
500	17	29	45	65	64	125	205	AAH0500M16
	21							AAH0500M20
630	17	33.5	45	65	68	140	225	AAH0630M16
	21							AAH0630M20
800	21	37.6	58	84	78	147	250	AAH0800M20
	27							AAH0800M25
1000	21	41.5	60	87	90	160	280	AAH1000M20
	27							AAH1000M25

Compression Joints Aluminium - Long Barrel

- Material** : Electrolytic Grade Al 99.5
Finish : Bright or Electro-tinned
Features : Barrel Prefilled with Oxide inhibiting Compound
 & Capped at both end

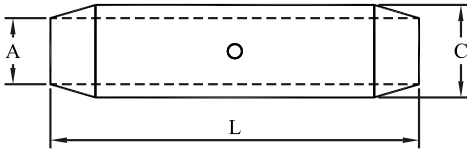

Cable Size mm ²	Dimensions in mm			E-Code
	A	C	L	
16	5.5	11	55	AAJ0016
25	6.5	15	70	AAJ0025
35	8	15	85	AAJ0035
50	9.7	18	85	AAJ0050
70	11	18	106	AAJ0070
95	13.1	20	106	AAJ0095
120	14.7	22	106	AAJ0120
150	16.5	25	135	AAJ0150
185	18.1	28	135	AAJ0185
240	21	28	145	AAJ0240
300	23.2	34	150	AAJ0300
400	26	38	205	AAJ0400
500	29	45	205	AAJ0500
630	33.5	45	220	AAJ0630
800	37.6	58	280	AAJ0800
1000	41.5	60	280	AAJ1000

NOTE : REDUCTION TYPE ALSO AVAILABLE

Compression Cable Lugs - Bimetallic ADTL2 Series

Material : E-Copper & AL 99.5%

Finish : Bright

Features : Barrel Prefilled With Oxide Inhibiting Compound & Capped At The

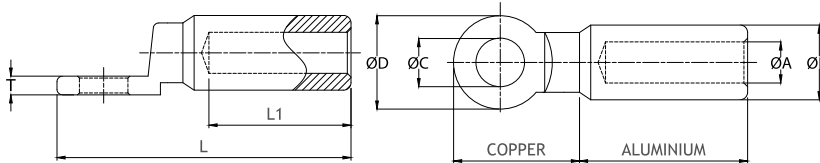

Cable Size mm ²	Dimensions in mm							E-Code
	ØA	ØB	ØC	ØD	L1	L1	L	
16	5.5	16	8.5	24	4	47	90	ADTL21608
			10.5					ADTL21610
			13					ADTL21612
25	6.5	16	8.5	24	4	47	90	ADTL22508
			10.5					ADTL22510
			13					ADTL22512
35	8.5	16	8.5	24	4	47	90	ADTL23508
			10.5					ADTL23510
			13					ADTL23512
50	9.5	20	8.5	24	5	50	98	ADTL25008
			10.5					ADTL25010
			13					ADTL25012
70	11	20	8.5	24	5	50	98	ADTL27008
			10.5					ADTL27010
			13					ADTL27012
95	12.5	20	8.5	24	5	50	98	ADTL29508
			10.5					ADTL29510
			13					ADTL29512
120	15	25	10.5	30	6	60	117	ADTL212010
			13					ADTL212012
			17					35
150	16	25	10.5	30	6	60	117	ADTL215010
			13					ADTL215012
			17					35
185	17	32	10.5	30	6	60	117	ADTL218510
			13					ADTL218512
			17					35
240	20	32	10.5	30	6	60	117	ADTL224010
			13					ADTL224012
			17					35
300	23.3	34	10.5	30	6	60	117	ADTL230010
			13					ADTL230012
			17					36
500	26	40	13	36	8	90	160	ADTL240012
			17					ADTL240016
			-					ADTL2400BL
500	29	47	17	SQ 60 x 60	10	94	200	AXBM50016
			21					AXBM50020
			-					AXBM500BL
	17	50	10	70	165	AXBM50016R		
						21	AXBM50020R	
						-	AXBM500BLR	
630	32.5	47	17	SQ 60 x 60	10	94	200	AXBM63016
			21					AXBM63020
			-					AXBM630BL
	17	50	10	70	165	AXBM63016R		
						21	AXBM63020R	
						-	AXBM630BLR	

Compression Cable Lugs - Bimetallic ADTL3 Type

Material : E-Copper & AL 99.5%

Finish : Bright

Features : Barrel Prefilled With Oxide Inhibiting Compound & Capped At The

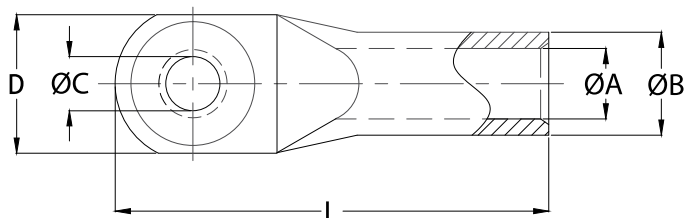

Cable Size mm ²	Dimensions in mm					E-Code
	ØA	ØB	ØC	D	L	
16	5.5	12	10.5	24	72	ADTL31610
			13			ADTL31612
25	6.5	12	10.5	24	72	ADTL32510
			13			ADTL32512
35	8.5	14	10.5	25	82	ADTL33510
			13			ADTL33512
50	10	16	10.5	27	87	ADTL35010
			13			ADTL35012
70	11.5	18	10.5	32	102	ADTL37010
			13			ADTL37012
95	13.5	22	10.5	35	106	ADTL39510
			13			ADTL39512
120	15	22	10.5	35	112	ADTL312010
			13			ADTL312012
150	16.5	25	10.5	35	125	ADTL315010
			13			ADTL315012
185	18.5	28	13	42	133	ADTL318512
			17			ADTL318516
240	21	32	13	46	140	ADTL324012
			17			ADTL324016
300	23.5	34	13	50	155	ADTL330012
			17			ADTL330016
400	26.5	38	13	58	170	ADTL340012
			17			ADTL340016

Bimetallic Joints - Straight Type

Material : Electrolytic Grade AL 99.5 and Copper

Finish : Bright

Features : Barrel Prefilled with Oxide inhibiting Compound & Capped

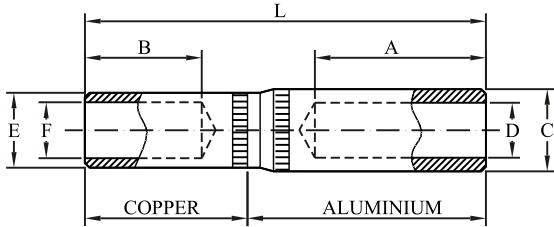

Cable Size (AL)mm ²	Cable Size (CU)mm ²	Dimensions in mm							E-Code
		A	B	C	D	E	F	L	
25	25	32	21.5	12	7	9.7	7	70	ABMCS25
35	35	32	21.5	12	8.5	11.5	8.4	70	ABMCS35
50	50	32	21.5	16	9.5	12.7	9.5	70	ABMCS50
70	70	32	21.5	16	11	14.3	11.1	70	ABMCS70
95	95	60	40	21.5	13	17.5	13.5	120	ABMCS95
120	120	60	40	21.5	15	20.6	15.5	120	ABMCS120
150	150	60	40	27	16.5	22.2	16.3	120	ABMCS150
185	185	60	40	27	18.5	24.3	18.3	120	ABMCS185
240	240	60	40	35	21	28.6	21.2	122	ABMCS240
300	300	60	40	35	23.5	31.9	23.8	125	ABMCS300
400	400	70	55	47	26.5	34.9	26.8	153	ABMCS400
500	500	70	58	47	29.5	38	30	155	ABMCS500
630	630	70	60	54	33.5	45	33.5	160	ABMCS630

Bimetallic Joints - Reducing Type

Material : Electrolytic Grade AL 99.5 and Copper

Finish : Bright

Features : Barrel Prefilled with Oxide inhibiting Compound & Capped

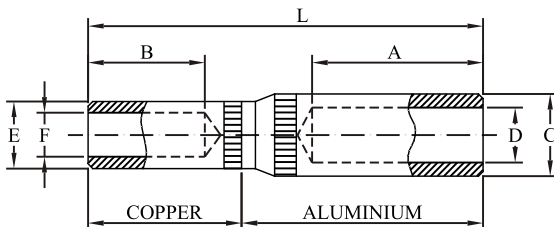

Cable Size (AL)mm ²	Cable Size (CU)mm ²	Dimensions in mm							E-Code
		A	B	C	D	E	F	L	
35	25	32	21.5	12	8.5	9.7	7	70	ABMC3525
50	35	32	21.5	16	9.5	11.5	8.4	70	ABMC5035
70	50	32	21.5	16	11	12.7	9.5	70	ABMC7050
95	70	60	40	21.5	13	14.3	11.1	70	ABMC9570
120	70	60	40	21.5	15	14.3	11.5	120	ABMC1270
120	95	60	40	21.5	15	17.5	13.5	120	ABMC1295
150	120	60	40	27	16.5	20.6	15.5	120	ABMC1512
185	70	60	40	27	18.5	14.3	11.5	120	ABMC1870
185	150	60	40	27	18.5	22.2	16.3	120	ABMC1815
240	100	60	40	35	21	17.5	13.5	122	ABMC2410
240	185	60	40	35	21	24.3	18.3	122	ABMC2418
300	185	60	40	35	23.5	24.3	18.5	125	ABMC3018
300	240	60	40	35	23.5	28.6	21.2	125	ABMC3024
400	185	70	55	47	28.5	24.3	18.3	153	ABMC4018
400	300	70	55	47	26.5	31.9	23.8	153	ABMC4030
500	400	70	58	47	29.5	34.9	26.8	155	ABMC5040
630	500	70	60	54	33.5	38	30	160	ABMC6350

Compression Midspan Joints (Full Tension) - Aluminium

Material : All Alloy Tube

Finish : Bright

Application: For AAC & AAAC Conductor

Features : Cable stop facility, Barrel Prefilled with Oxide inhibiting Compound & Capped at both ends

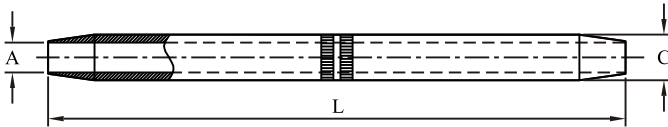

Cable Size mm ²	Dimensions in mm			E-Code
	A	C	L	
16	5.8	12	140	AAC0016
25	6.8	12	140	AAC0025
35	8	14	140	AAC0035
50	10	16	155	AAC0050
70	11.5	18.5	165	AAC0070
95	13.5	22	165	AAC0095
120	15.5	25.5	250	AAC0120
150	16.5	28.5	300	AAC0150
185	18.5	28.5	330	AAC0185
240	21.5	34.5	350	AAC0240
300	23.5	38.5	400	AAC0300

NOTE : OTHER SIZES AS PER CUSTOMER SPECIFICATION ALSO AVAILABLE

Compression Midspan Joints - Aluminium

Material : All Alloy & Hot dipped Galvanised Steel Tube

Finish : Bright

Application: For ACSR Conductor

Features : Barrel Prefilled with Oxide inhibiting Compound & Capped at both

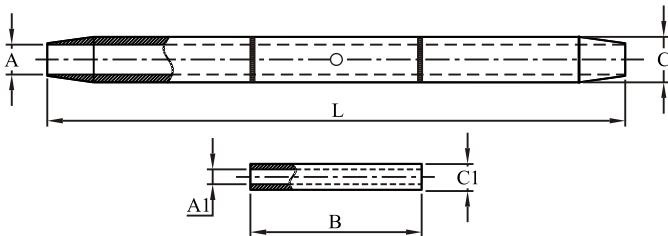

Cable Size mm ²	Code Name	Dimensions in mm						E-Code
		A	C	L	A1	C1	B	
35	FOX	9	16	235	-	-	-	AMS35
50	RABBIT	11.5	20.5	280	-	-	-	AMS50
70	BEAVER	13.2	22	330	-	-	-	AMS70
90	CAT	15	24	380	-	-	-	AMS90
100	DOG	15.5	24	410	5	10	120	AMS100
125	LEOPARD	17.2	26	510	5.6	12	160	AMS125
150	WOLF	19.4	30	560	8.1	16	180	AMS150
175	LYNX	21	32	610	8.7	18	205	AMS175
200	PANTHER	22	34	610	9.4	20	205	AMS200
225	LION	23.6	36	610	9.9	20	205	AMS225
250	BEAR	24.8	38	690	10.5	22	230	AMS250
300	GOAT	27.3	40	690	11.6	22	230	AMS300
400	DEER	31.3	46	715	13.3	26	250	AMS400D
400	ZEBRA	30	46	715	10	20	250	AMS400S
500	MOOSE	33.3	52	740	11	22	250	AMS500

NOTE : OTHER SIZES AS PER CUSTOMER SPECIFICATION ALSO AVAILABLE

Split Bolt Connectors

Material : Extruded / Forged Brass Section BS2874

Finish : Electro-Tinned / Untinned or Copper Plated

Cable Size mm ²	Dimensions in mm		E-Code
	A		
10	4.5		SBC10B
16	6		SBC16B
25	6.9		SBC25B
32-35	8.1		SBC35B
50	9.7		SBC50B
70	11.2		SBC70B
95	13.6		SBC95B
100	14		SBC100B
120	15		SBC120B
150	16.6		SBC150B
185	18.2		SBC185B
240	21.4		SBC240B
300	23.7		SBC300B
400	26.2		SBC400B
500	30.1		SBC500B

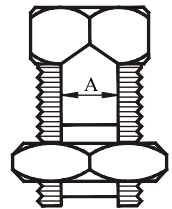

NOTE : FOR COPPER PLATED ADD SUFFIX 'C', FOR TIN PLATED ADD SUFFIX 'T'

Split Bolt Connectors R-Series

Material : Extruded / Forged Brass Rod

Finish : Electro-Tinned / Untinned or Copper Plated

Cable Size mm ²	Dimensions in mm		E-Code
	A		
16	5.3		SBCR16
25	6.9		SBCR25
35	8.3		SBCR35
50	9.5		SBCR50
70	10.9		SBCR70
95	12.9		SBCR95
120	15		SBCR120
150	16.6		SBCR150
185	18.5		SBCR185

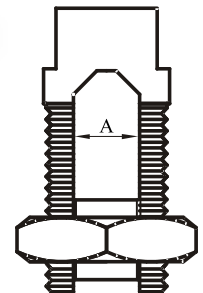
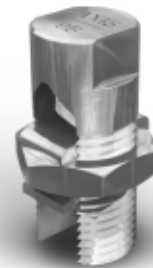

NOTE : FOR COPPER PLATED ADD SUFFIX 'C', FOR TIN PLATED ADD SUFFIX 'T'

Servit Post Split Bolt Connectors

Material : Extruded / Forged Brass Rod

Finish : Electro-Tinned / Untinned or Copper Plated

Cable Size mm ²	Dimensions in mm		Stud Size		E-Code
	A		D	L	
25	6.6		M 10	30	SBCP25
35	7.8		M 10	30	SBCP35
50	9.8		M 12	30	SBCP50
70	11.1		M 12	30	SBCP70
95	14		M 12	30	SBCP95
120	15.5		M 12	30	SBCP120

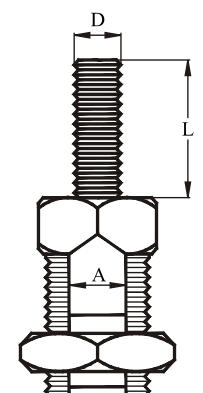

NOTE : FOR COPPER PLATED ADD SUFFIX 'C', FOR TIN PLATED ADD SUFFIX 'T'

Aluminium Line Tap ('V' Type)

Material : Electrolytic Grade High Strength Aluminium Alloy

Finish : Natural & Degreased

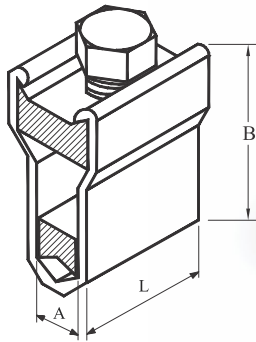

Plastic Cover



Cable Size mm ²	Dimensions in mm			E-Code
	A	C	L	
16-25	10	41	32	AVC1625
35-50	10	41	32	AVC3550
50-70	11.2	41	32	AVC5070
95-100	15	57	51	AVC95100

Parallel Groove Connectors - Bimetallic

Material : Aluminium Alloy with Copper Linings

Bolts - Galvanised

Finish : Bright

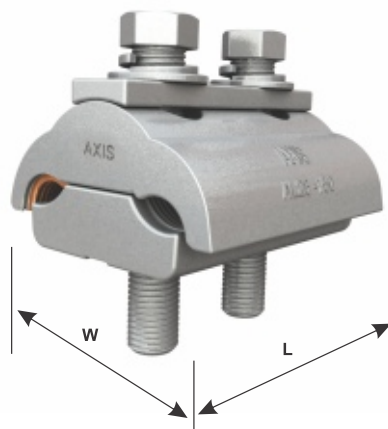

Conductor Size mm ²		Conductor Ømm		Dimensions In mm		No. Of Bolts	E-Code
Al	Cu	Al. MAX	Cu.Al. MAX	W	L		
16 - 70	6 - 50	6 - 12	3.5 - 9	42	40	2	PGBM00006B2
25 - 150	10 - 95	7 - 16	4 - 13	46	50	2	PGBM00007B2
25 - 200	25 - 185	7 - 19	7 - 18	58	64	2	PGBM00009B2
35 - 300	35 - 240	8 - 26	8 - 21	64	105	3	PGBM00008B3

Parallel Groove Connectors AL/AL

Material : Extruded Aluminum Alloy

Bolts - Galvanised

Finish : Bright / Tin Plating For Dual Purpose

TYPE - 1

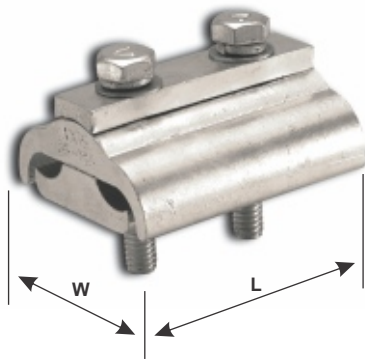

TYPE - 3

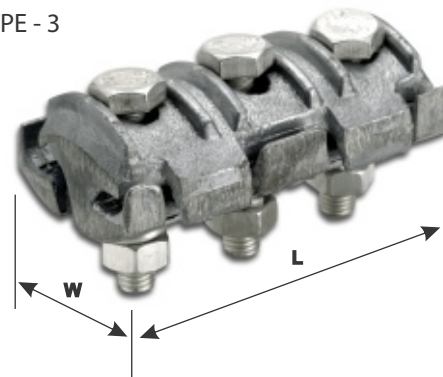

TYPE - 2

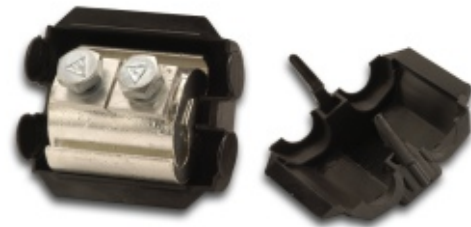
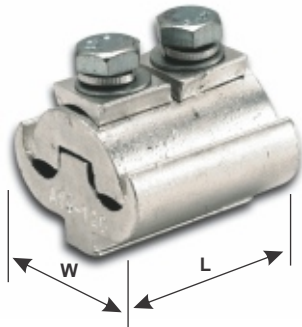

Conductor Size mm ²		Conductor Size mm	Dimensions In mm		No. Of Bolts	Type	E-Code
MIN	MAX		W	L			
16	70	4.5 - 11	36	46	2	1	APG00001B2
35	185	8.2 - 18	55	65	2	1	APG00003B2
35	185	8.2 - 18	55	97	3	1	APG00004B3
16	50	4.5 - 9.5	32	26	1	2	APG00005B1
16	120	4.5 - 13	44	42	2	2	APG00006T2B2
16	120	4.5 - 13	45	50	2	1	APG00002B2
16	120	4.5 - 13	45	75	3	1	APG00002B3
35	240	8.2 - 21	65	65	2	1	APG00013B2
35	240	8.2 - 21	65	97	3	1	APG00008B3
25	100	6.5-13.2	40	75	2	3	APG00010B2
70	150	11 - 16.3	53	98	3	3	APG00009B3

Customized Tailor Made Lugs & Connectors

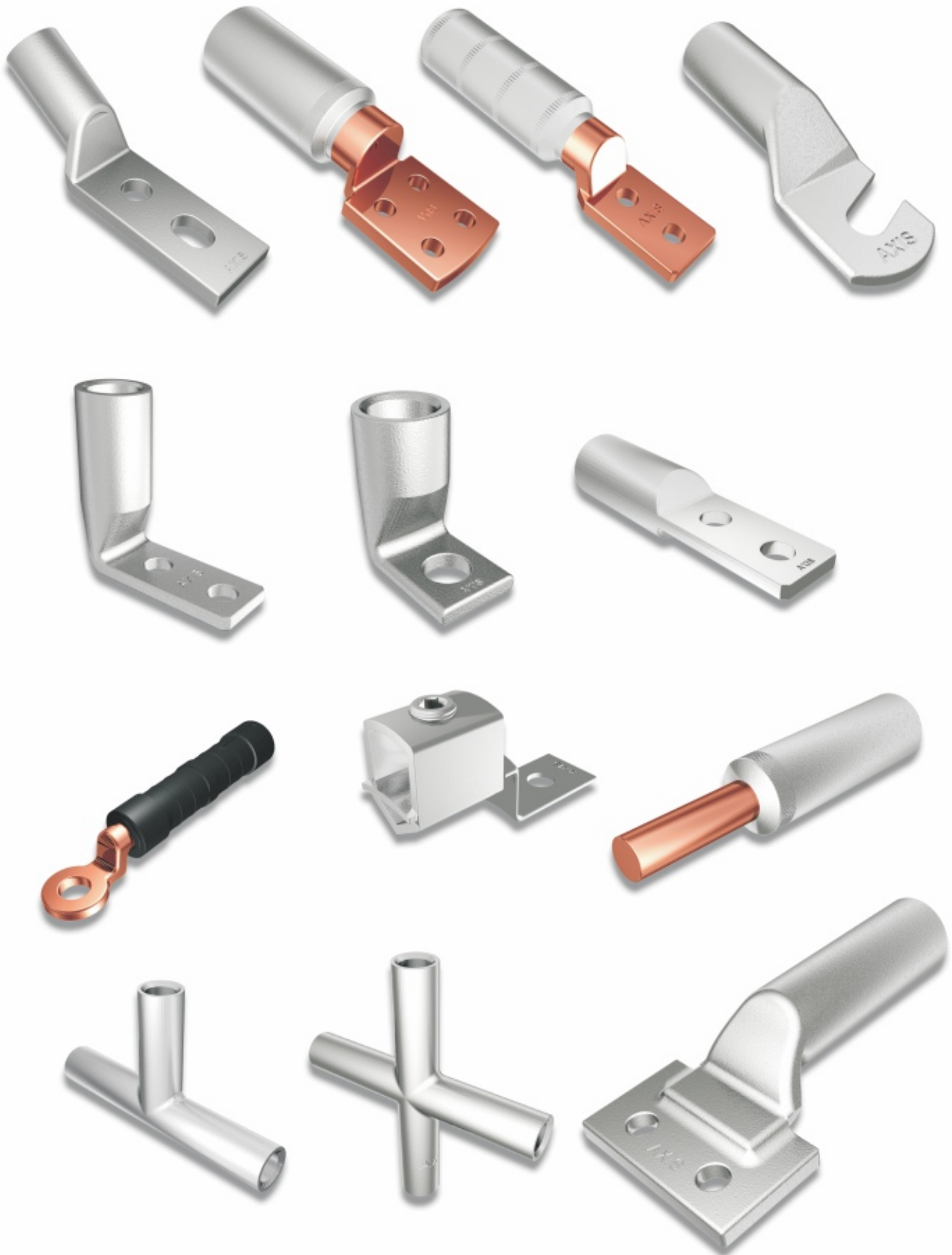

Flexible Copper Connectors

Material : EC Grade Copper

Finish : Natural Copper Or Tin Plated

Application : Flexible Electrical Connectors Solve High-voltage Connectivity Problems created by vibration from generators and transformers.



Earthing & Lightning Protection System and Exo Thermic Welding

AXIS provides complete range of E & LP products & system in order to achieve total protection to the Structures, Equipment and community. These products are manufactured in accordance to International standards such as BS EN, UL & IS



Electrical Connectors

Axis manufactures wide range of Lugs and Connectors sizes ranging from 1.5mm² -1200mm² of Copper, Aluminum & Bimetal. These products are Compression or Bolted type. Popular standards such as BSEN, IS & UL are followed to manufacture and to test these Connectors.



Cable Management System

AXIS Cable Glands and accessories are manufactured according to the functional requirements of IEC 62444 and DIN standards. AXIS Cable Cleats are manufactured in accordance with IEC 61914.

AXIS Cable Ties can be supplied with other accessories like Markers, I.D. Tags & Carriers used in oil refineries, petrochemical industries and other utilities worldwide. These cable ties comply to UL-1565 and BS EN 62275 standards.



CERTIFICATIONS

AN ISO 9001 : 2015 COMPANY



Underwriter Laboratories Inc. (UL)
 Grounding and Bonding Equipment
 UL-4143: 2012-2016-03
 Wire Connectors and Soldering Lugs
 UL-4141: 2012-2016-02



Power Grid Corporation of India Limited

NFC Standards



NATIONAL THERMAL POWER CORPORATION



STAR EXPORT HOUSE

Recognition by Government of India



An ISO 9001: 2015 Company

TESTED PRODUCTS
 EFFICIENT SERVICE
 TRUSTED BRAND

Poleline Hardware

AXIS offers complete range of OH line Hardware for LV, MV & HV Electrical distribution line systems. These products are manufactured taking into consideration international standards and Utility specific requirements.



2nd Edition

2020

Scan this code with your Whatsapp camera to talk to us



International Sales



Domestic Sales



AXIS ELECTRICAL COMPONENTS (I) P. LTD.

Registered Office: AXIS House, Plot No. 104 C

Administrative Office: Plot No. 149 BCD

Kandivali Co-op Industrial Estate Ltd., Kandivali (W),
Mumbai – 400067, Maharashtra, India. Tel: +91-22-67756000
email: sales@axis-india.com | Website: www.axis-india.com